

II 2GD  
Ex 60079-30-1 IIC Gb  
Ex 60079-30-1 IIIC Db

ATEX: CML 19ATEX3390U  
IECEX: CML 19.0133U  
UKEX: CML 21UKEX31146U

**BPS5**

FSEw-CT  
FSEw-CF  
FSUw-NF  
SM-B



Made in the UK

FFG#			BPS5						BES#			RTV0.5

**SPECIAL CONDITIONS FOR SAFE USE:**  
These termination kits and the cable that enters them shall be fixed to a secure mounting point.

The component shall only be used with constant power or self-regulating trace heating cables within the following ranges:  
-40°C to 180°C (Standard RTV), -40°C to 250°C (High temperature RTV).

This is particularly relevant when the trace heating cable is installed on pipework that has a temperature outside these ranges, in this situation, the termination devices shall be positioned outside the insulation, and the user/installer shall ensure that they are not exposed to UV radiation.

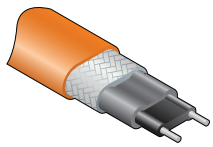
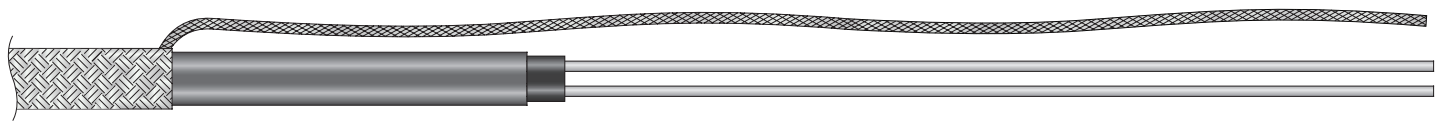
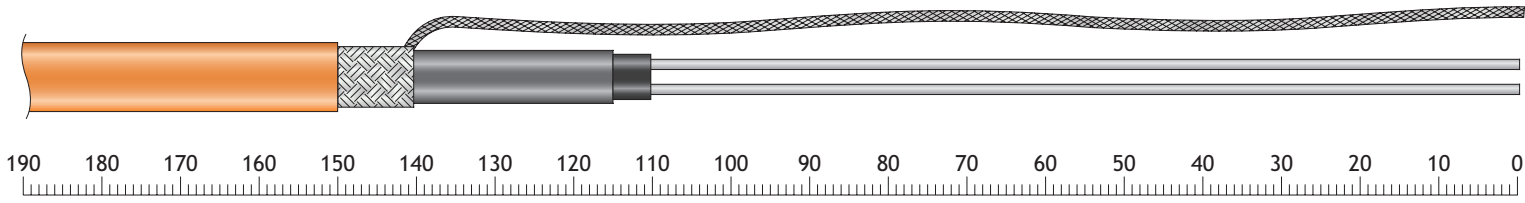
FSEw..CT/CF

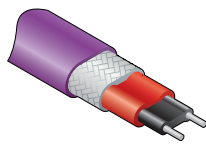

FSUw..NF

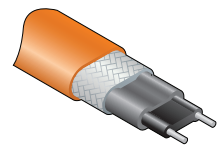

SM-B

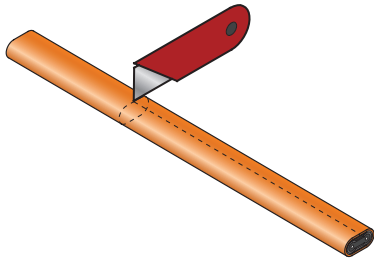

1

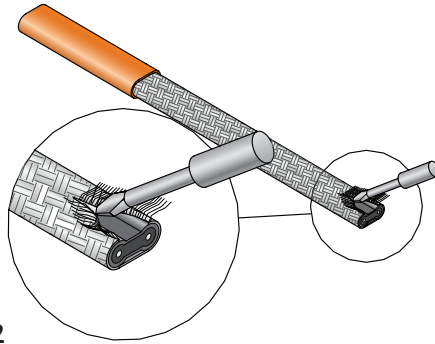

2

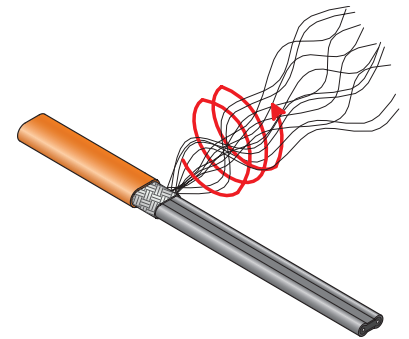

3

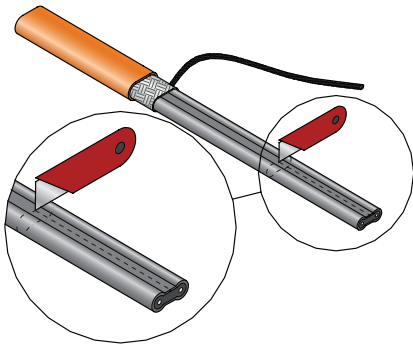

4

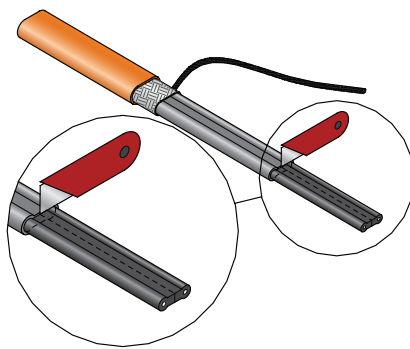

5

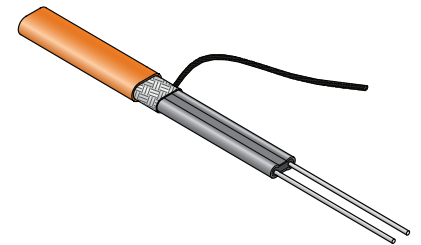

6

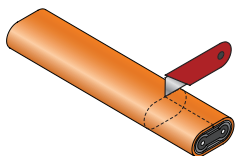
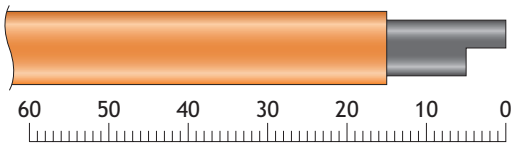

1

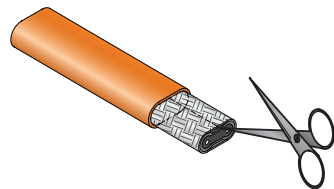

2

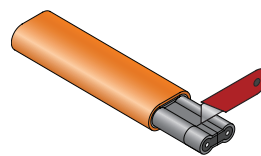

3

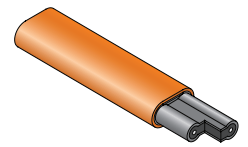

4