

**UTK 555**

FSEw - CT  
FSEw - CF  
SM - B  
FSUw - NF



Made in the UK

PGS5			BPS5					BES5			CL	RTV 40ml

**SPECIAL CONDITIONS FOR SAFE USE:**  
The cable glands are only suitable for fixed installations. Cables shall be effectively clamped to prevent pulling or twisting. The cable glands with the relevant cables and the plugs shall be used where a protection against risk of mechanical damage is provided. Cable glands have a working temp: -60°C to +80°C (M25 and silicone sealing rings)

**SPECIAL CONDITIONS FOR SAFE USE:**  
These termination kits and the cable that enters them shall be fixed to a secure mounting point.  
The component shall only be used with constant power or self-regulating trace heating cables within the following ranges: -40°C to +250°C (High temperature RTV). Please see website for safety data sheet.  
This is particularly relevant when the trace heating cable is installed on pipework that has a temperature outside these ranges, in this situation, the termination devices shall be positioned outside the insulation, and the user/installer shall ensure that they are not exposed to UV radiation.

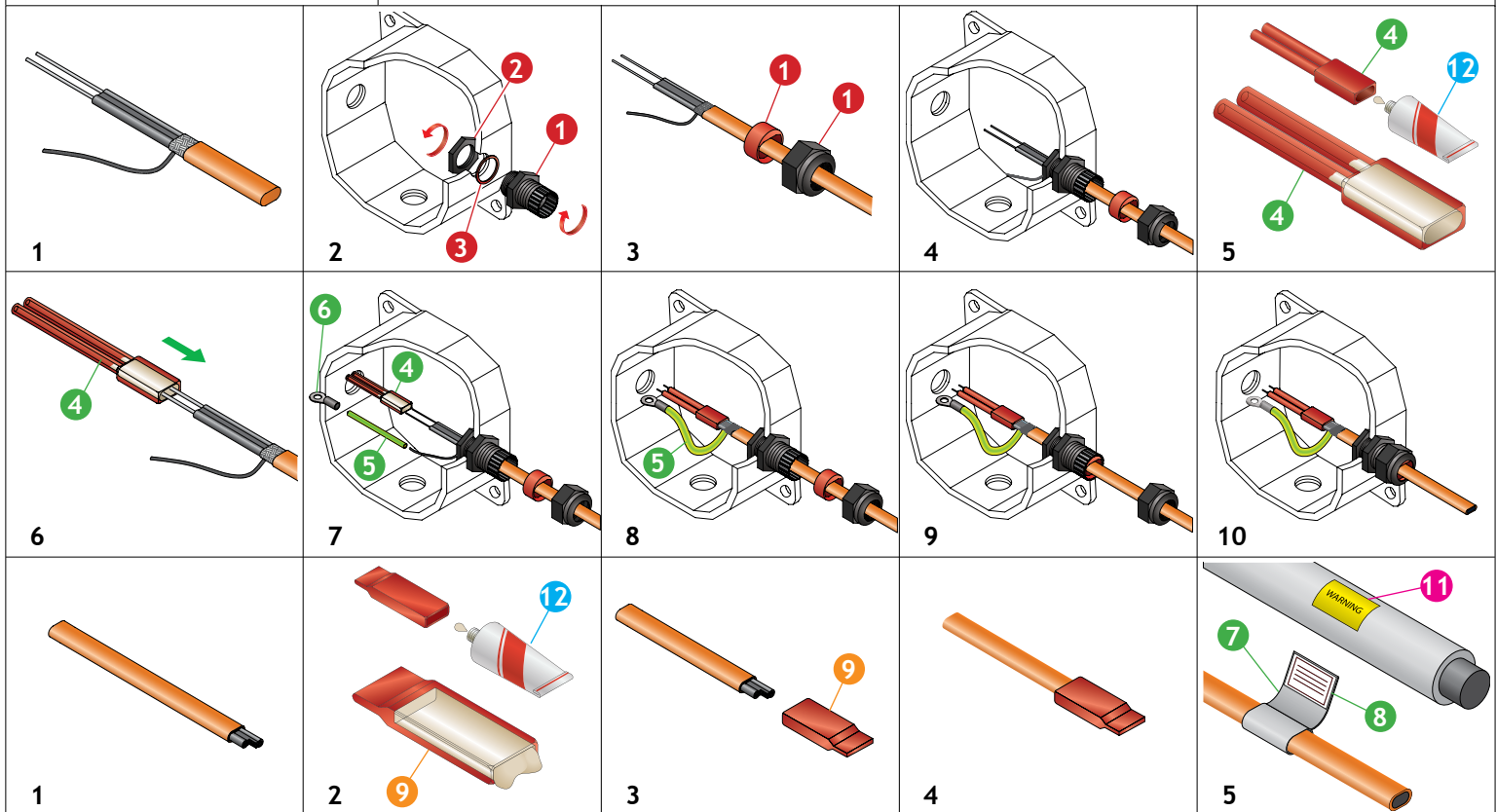

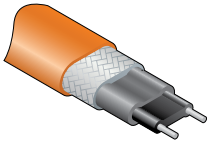
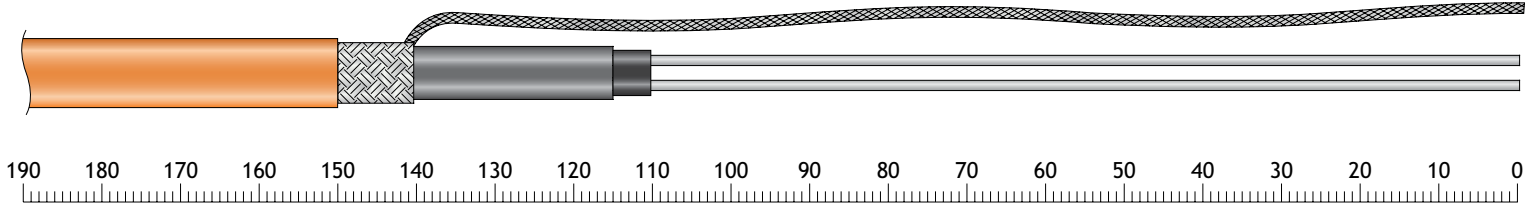

FSE(w)..CT

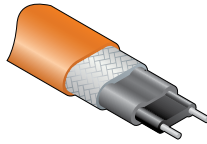

FSE(w)..CF

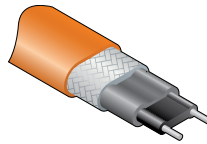

SM-B

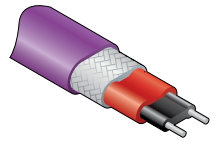

FSU(w)..NF

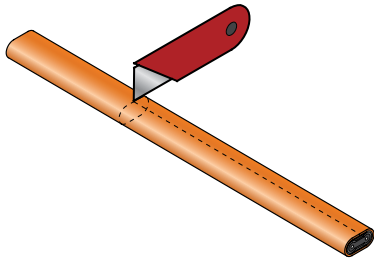

1

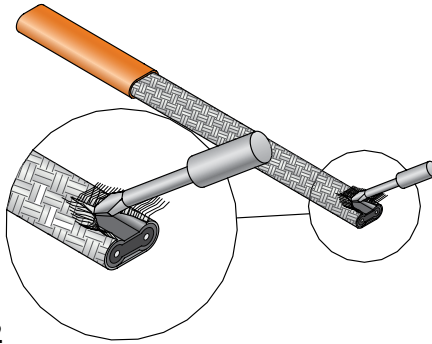

2

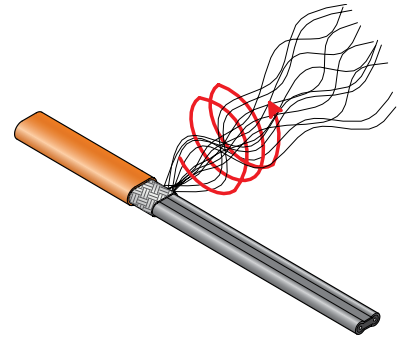

3

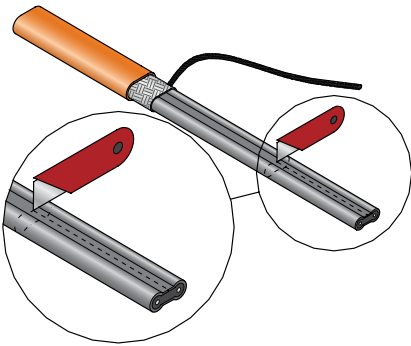

4

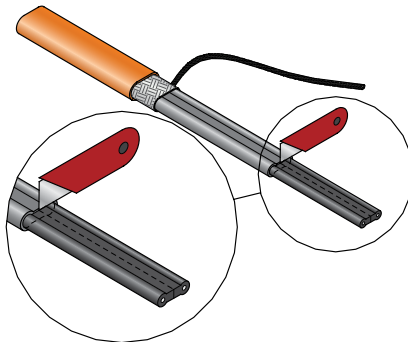

5

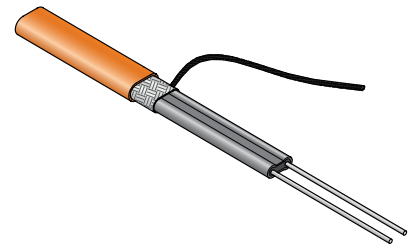

6

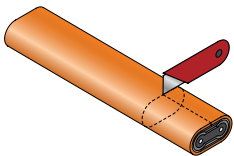
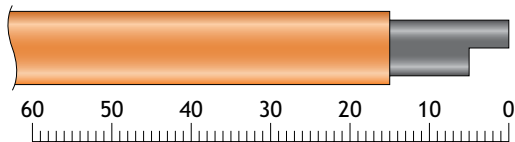

1

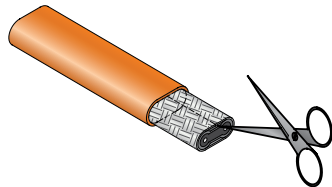

2

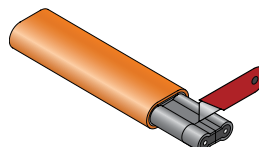

3

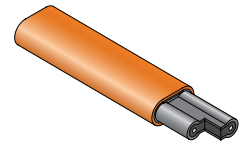

4