

CML 18 ATEX 3377U

Ex II 2G D  
Ex 60079-30-1 IIC Gb  
Ex 60079-30-1 IIIC Db  
Ts=-40°C to +90°C

**TK / HTS1FAR / MED / P & B**

LongLine LLR Cable  
(supplied separately)  
For splice connection  
of HTS1FAR 12.6 and 19.6  
heating cable.



Made in the UK

(Mar 23)

ITEM	DESCRIPTION	QTY	COMMENTS
1	Connector	1	14mm Ø
2	Enclosure	1	33mm Ø
3	Gland	2	P - M25 for HTS1FAR 12.6 & 19.6 B - M20 for HTS1FAR 12.6 & 19.6
4	Silicone Sealant	100ml	
5	Constant force spring	2	
6	Earth Braid & Coloured Sleeve	1	
7	Self-amalgamating tape	1	

Tools required



# Prepare Heater Cable

Use tools: 2 5 6 8

Heater - Aluminium outer jacket only



200mm

Heater - with optional outer jacket

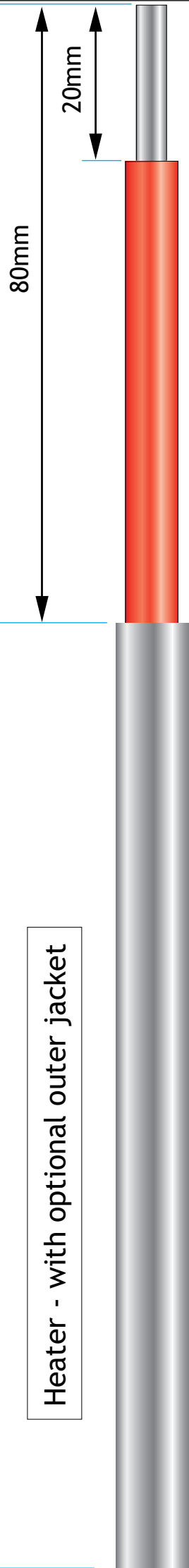

200mm

Cold Lead

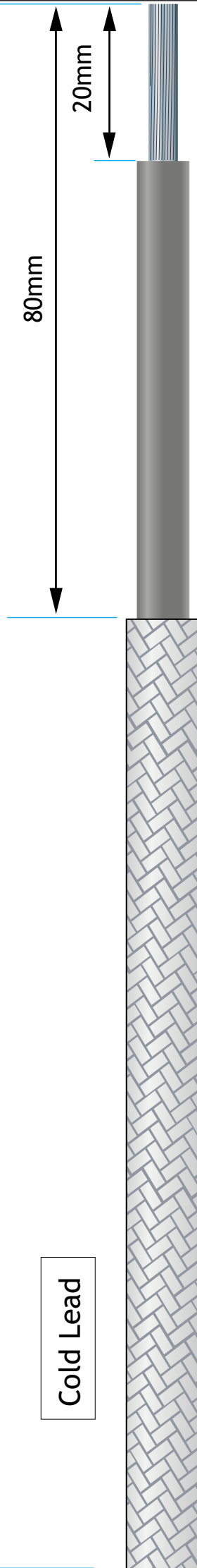

# Assembly of Termination

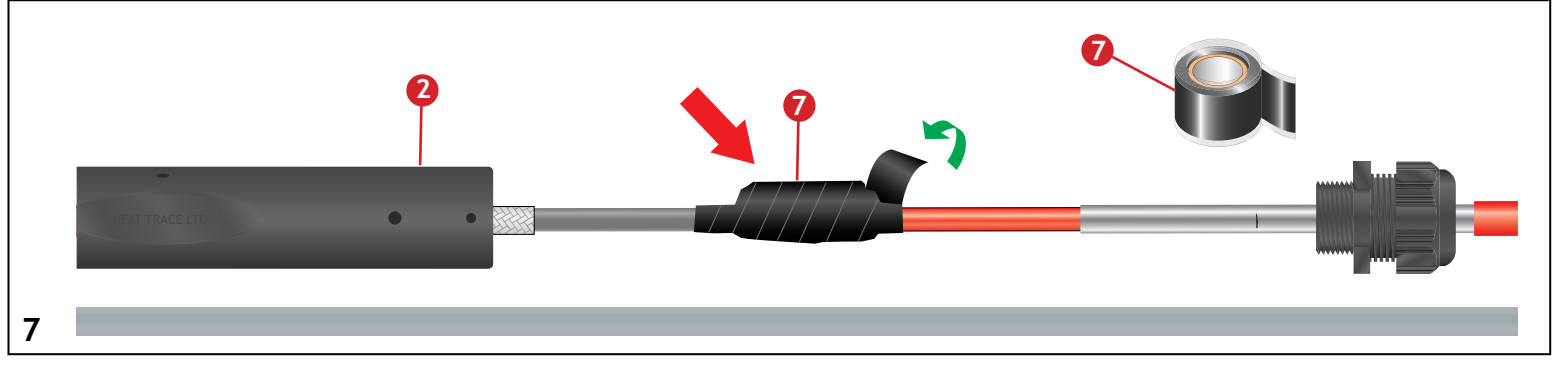
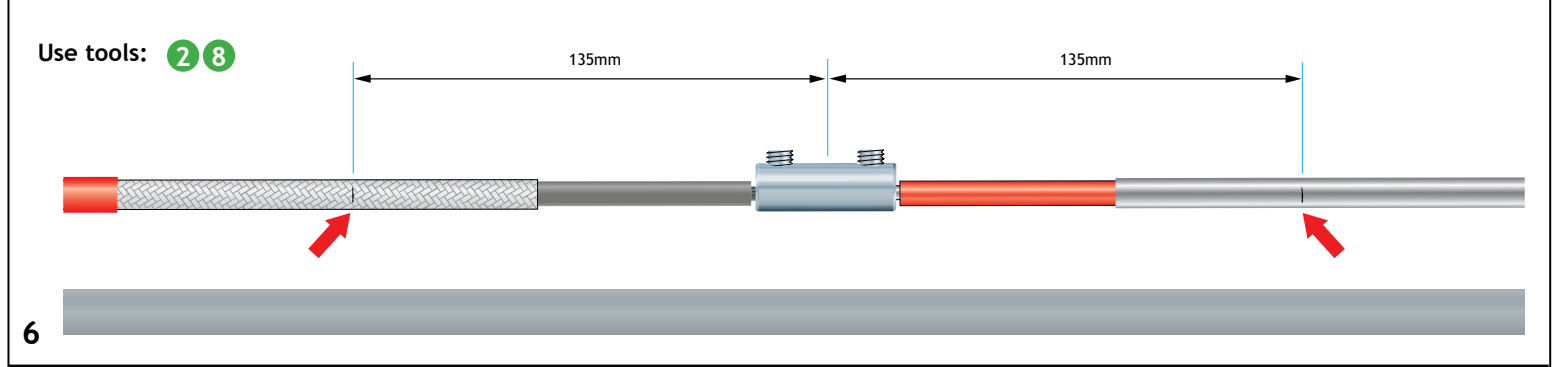
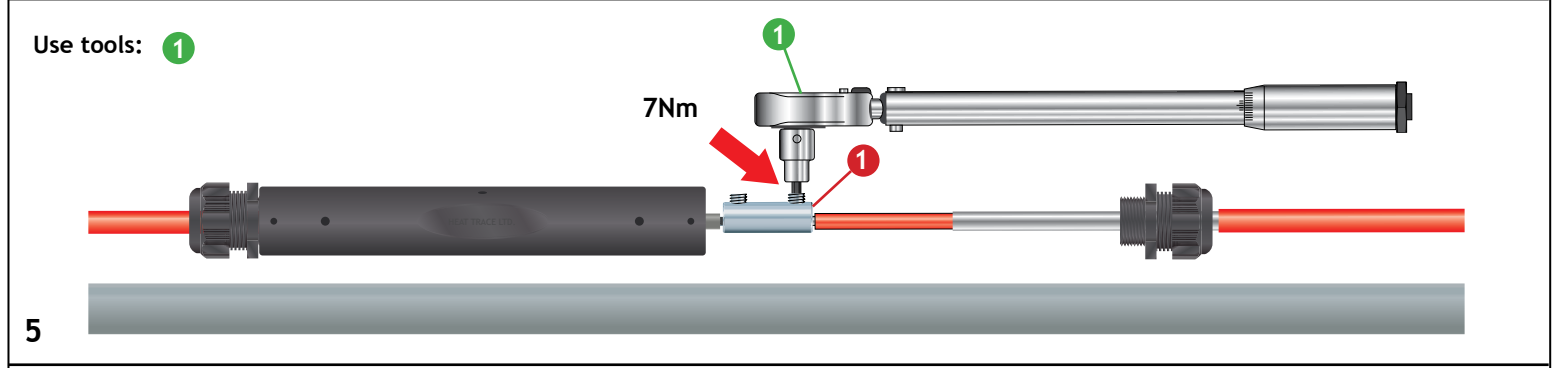
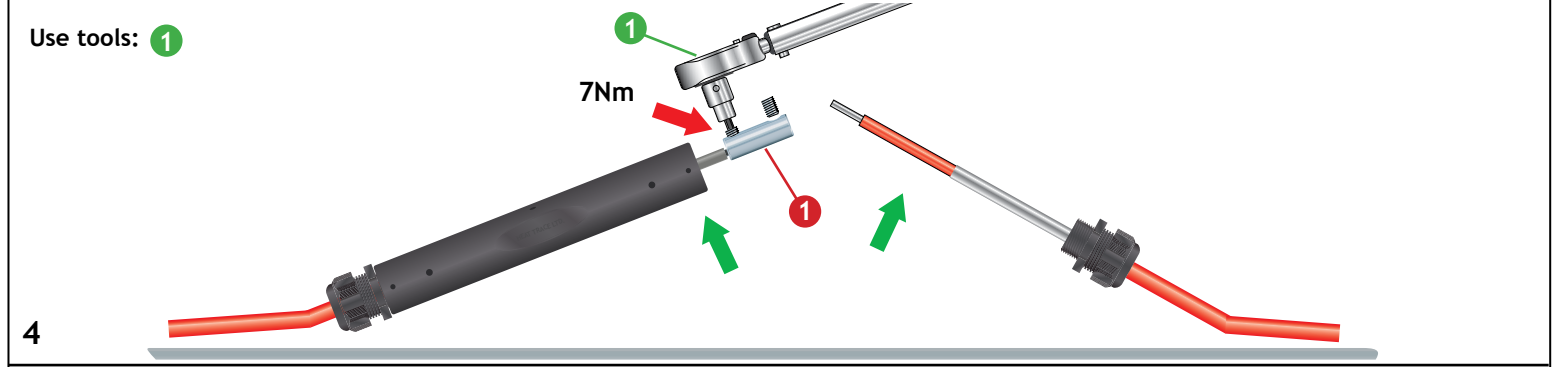
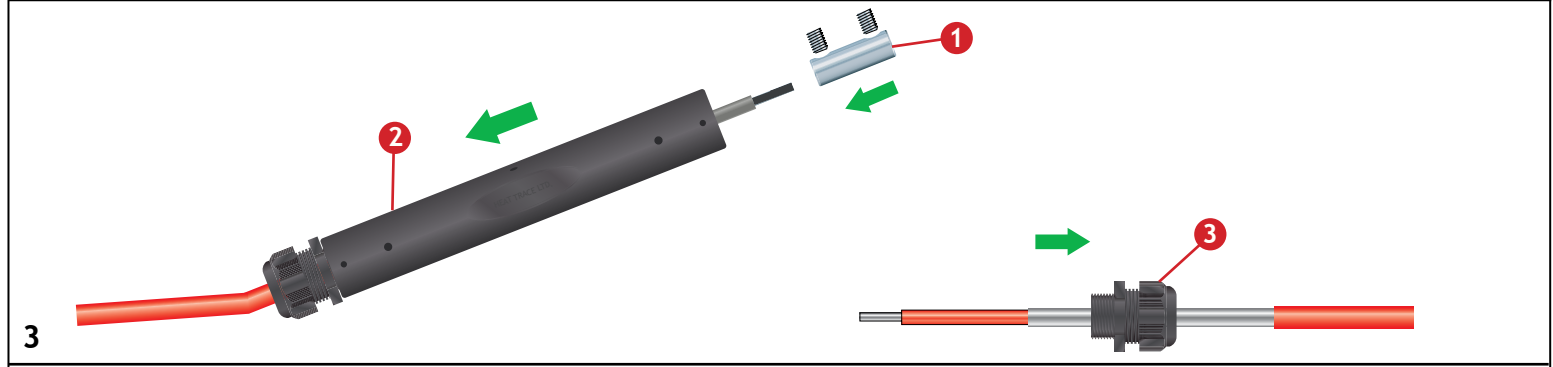
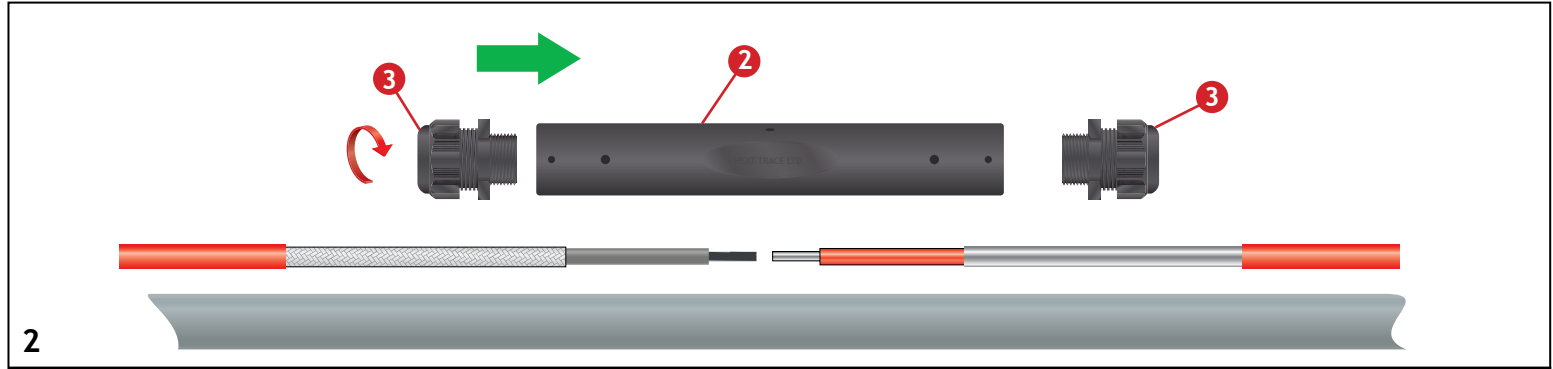

# Assembly of Termination

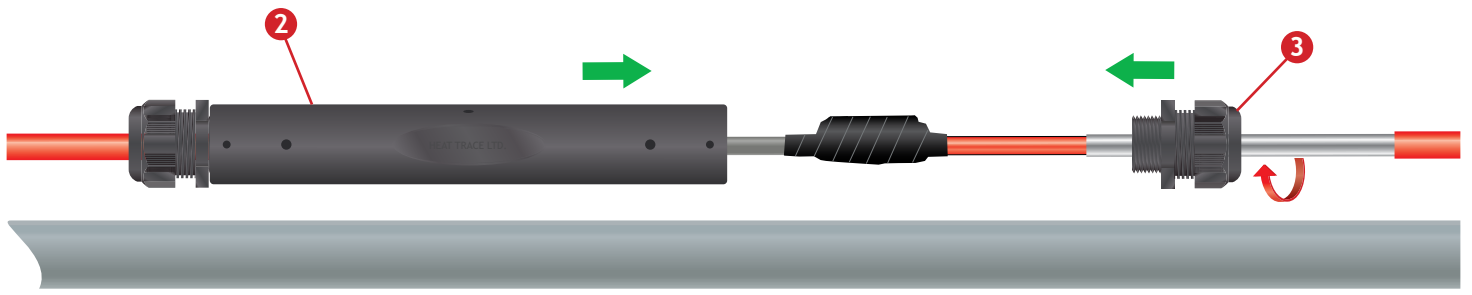

8

Use tools: 4

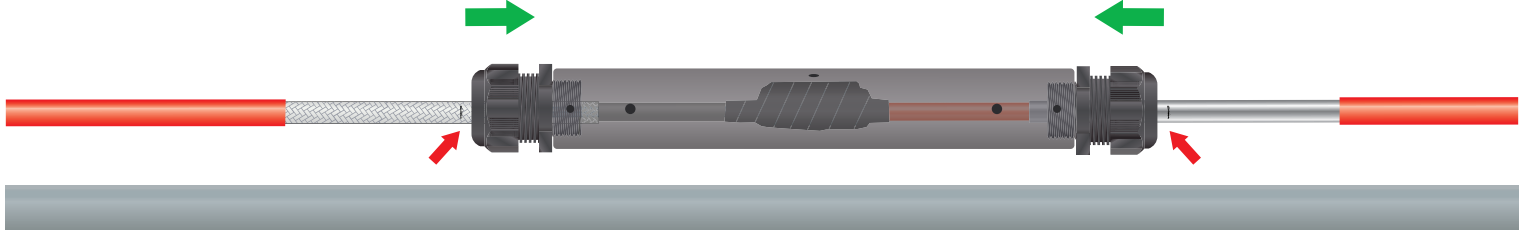

9

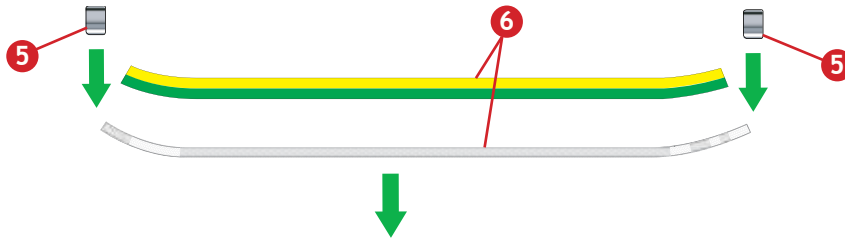

10

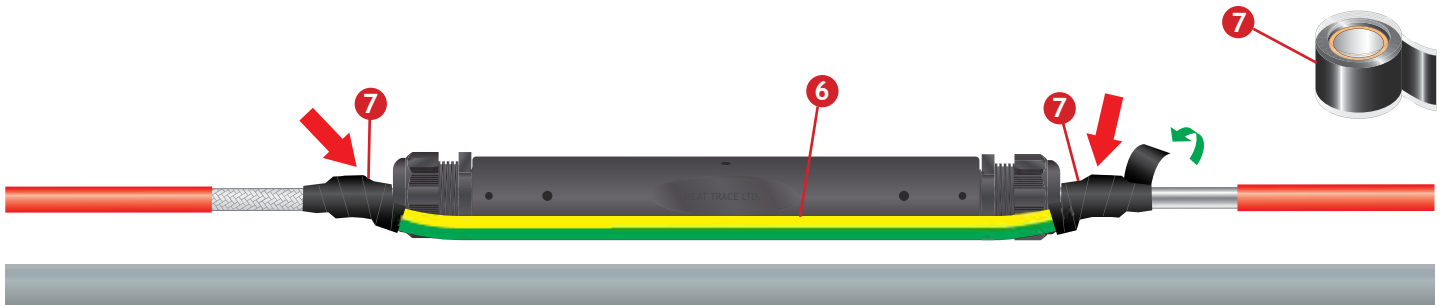

11

Use tools: 3 7

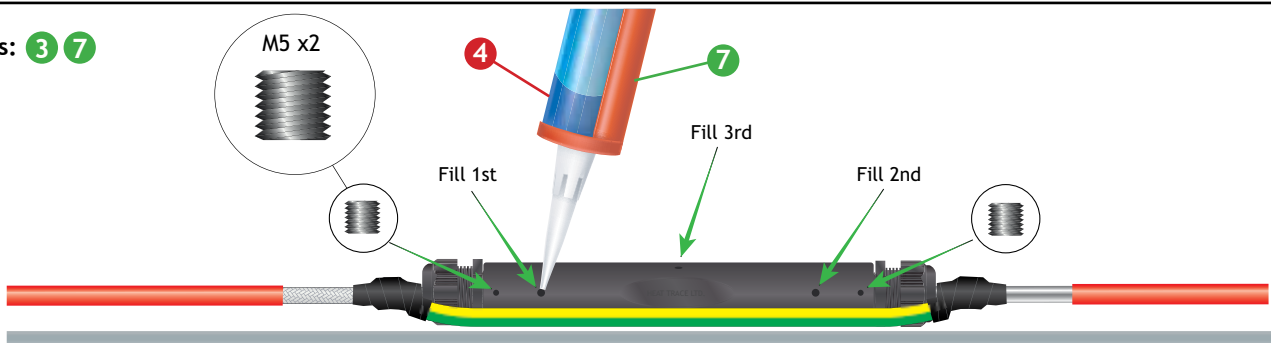

12

Use tools: 3

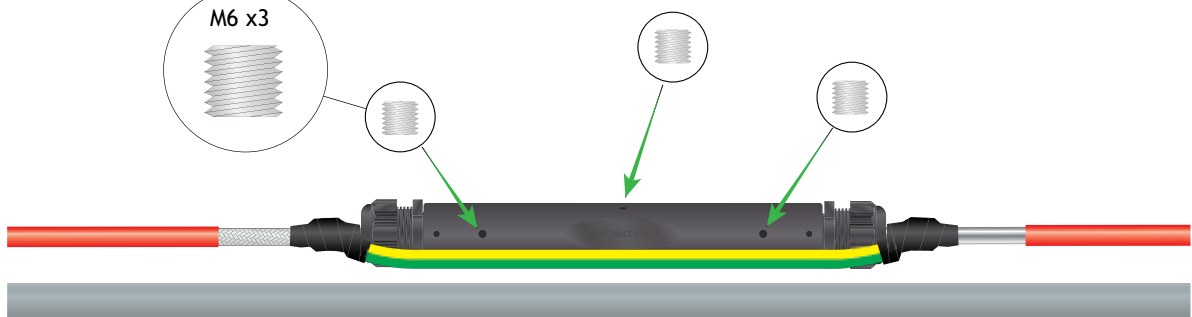

13