

CML 18 ATEX 3377U  
 II 2G D  
 Ex 60079-30-1 IIC Gb  
 Ex 60079-30-1 IIIC Db  
 Ts=-40°C to +90°C

**SK / HTS1FAR / SML / P & B**

**LongLine LLR Cable**  
(supplied separately)

For splice connection  
of HTS1FAR 3.1 and 7.1  
sized heating cables.



**Made in the UK**

(Jun 23)

ITEM	DESCRIPTION	QTY	COMMENTS
1	Connector	1	10mm Ø
2	Enclosure	1	33mm Ø
3	Gland	2	M25 for HTS1FAR 3.1 & 7.1
4	Silicone Sealant	100ml	
5	Constant force spring	2	
6	Earth Braid & Coloured Sleeve	1	
7	Self-amalgamating tape	1	

**Tools required**



## Prepare Heater Cable

Use tools: 2 5 6 8

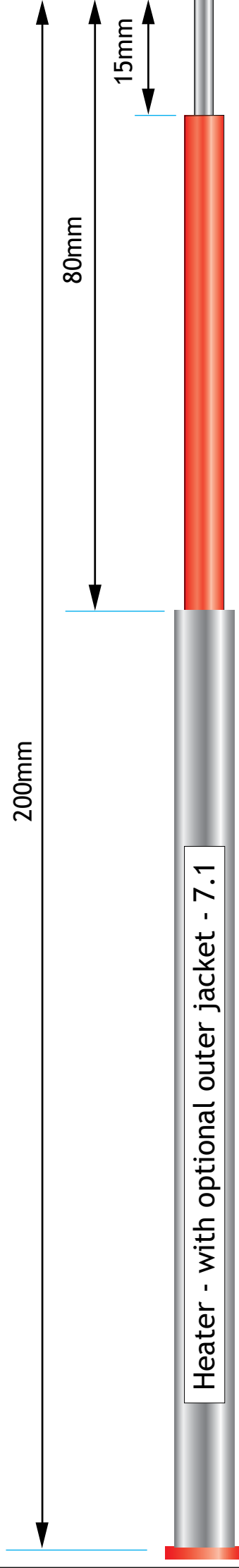
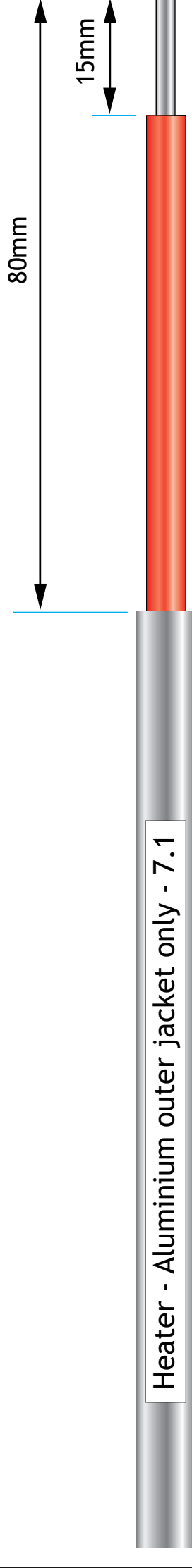
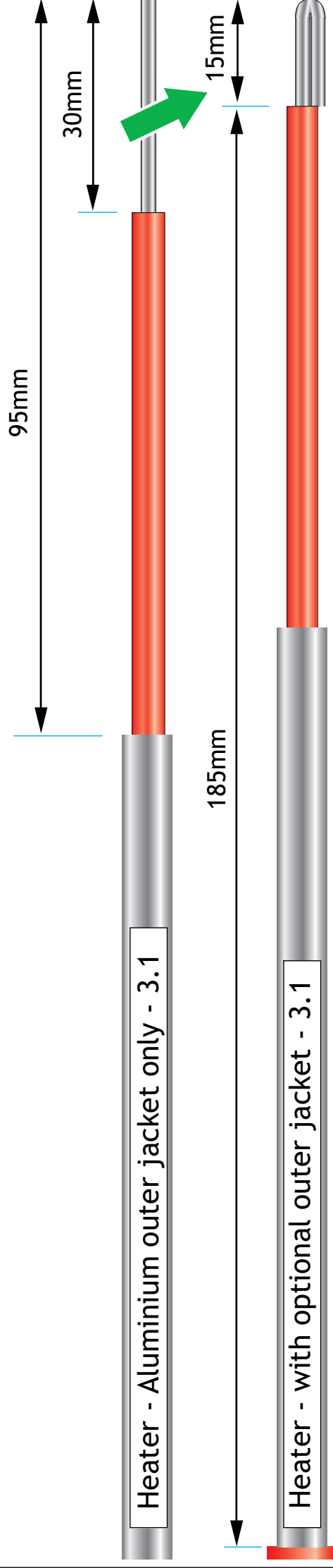

# Assembly of Termination

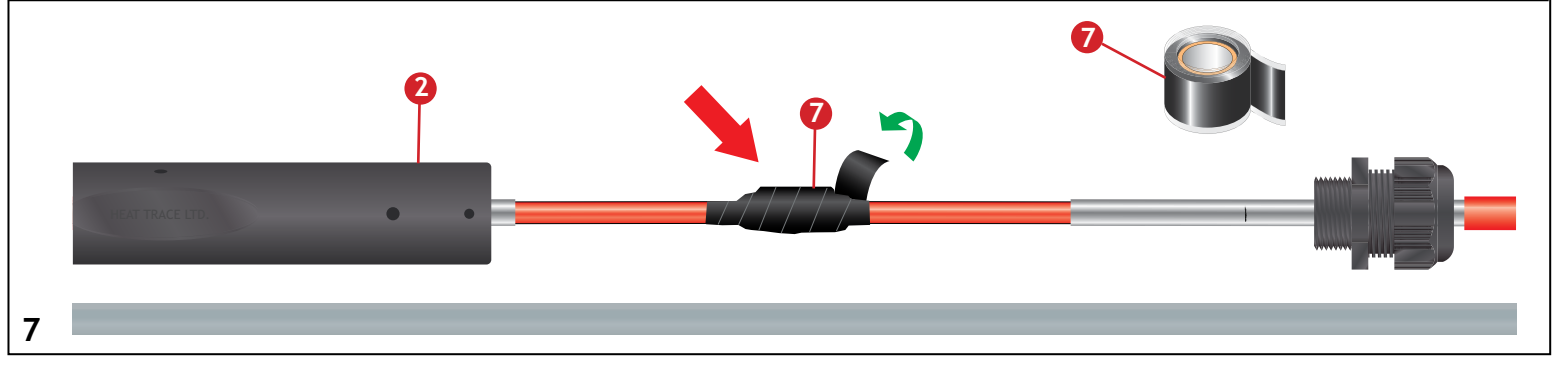
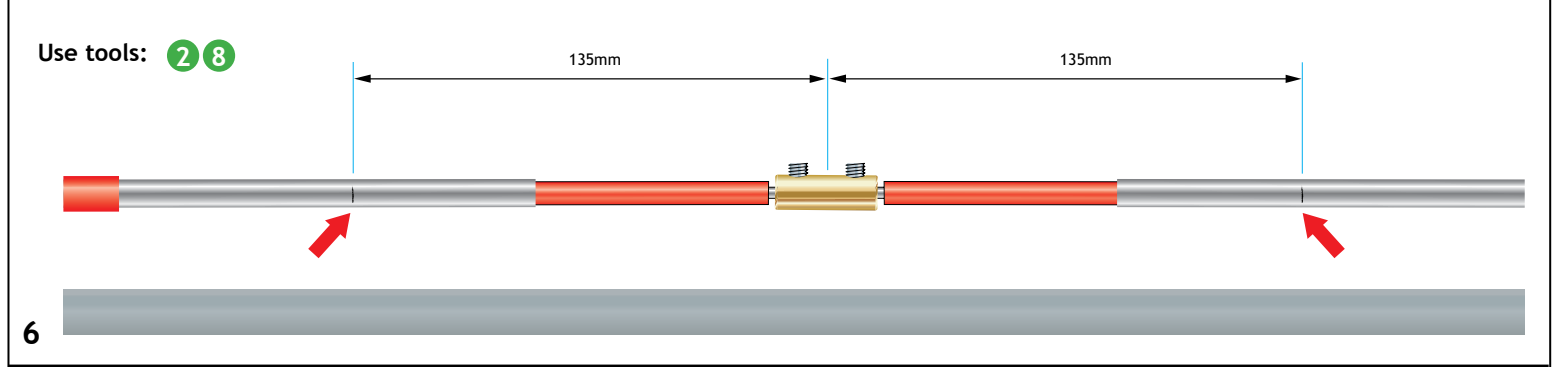
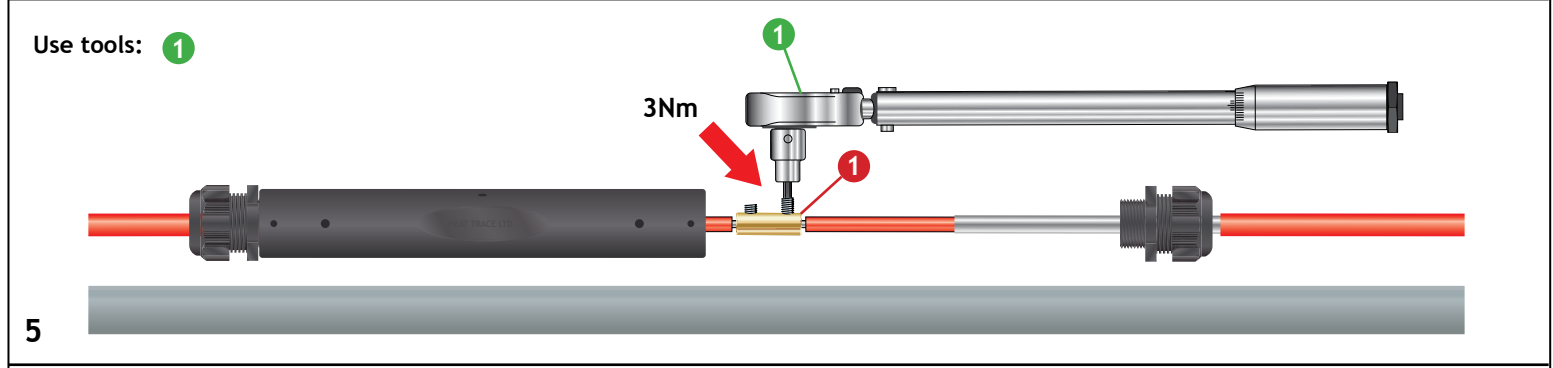
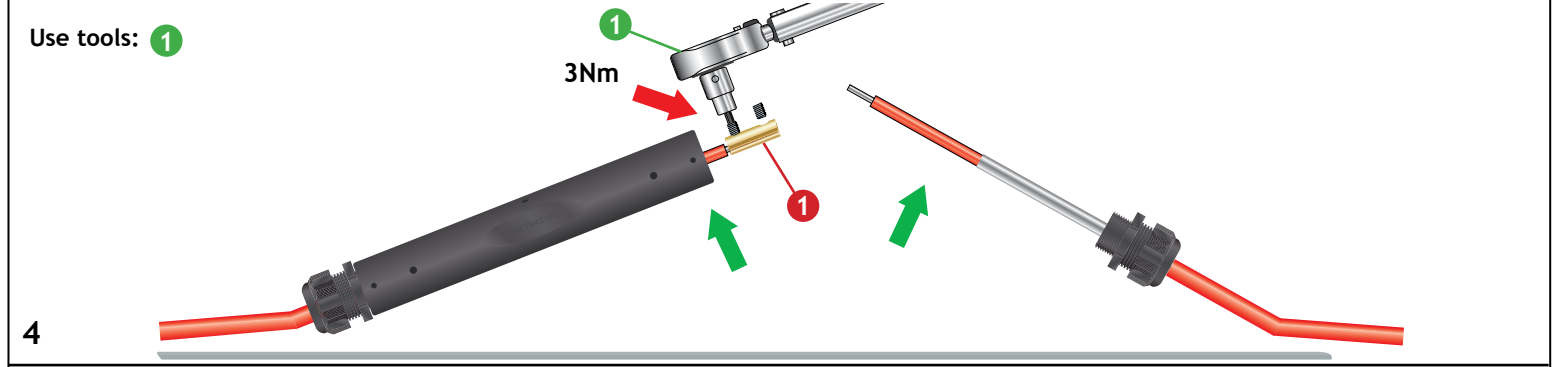
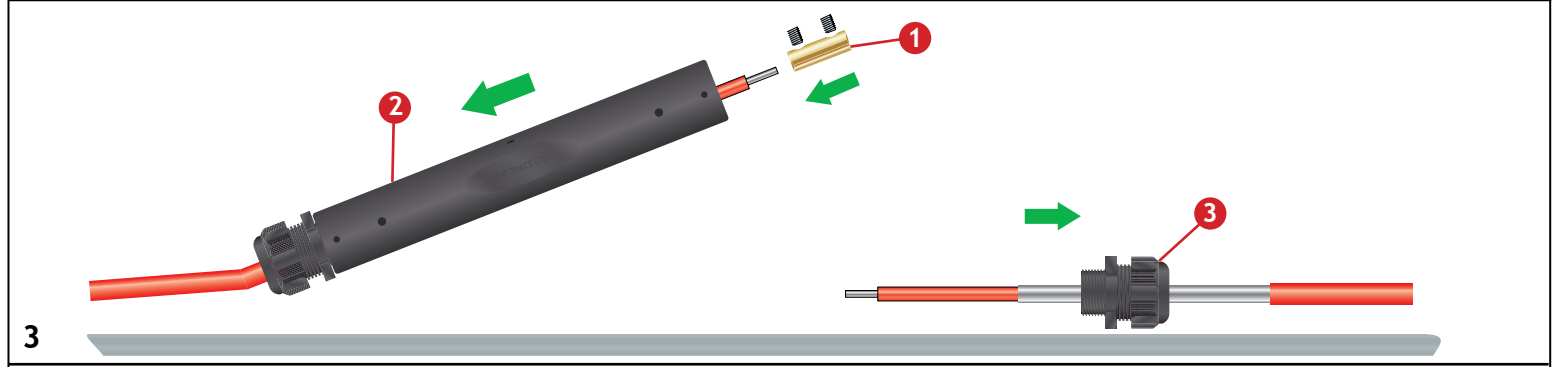
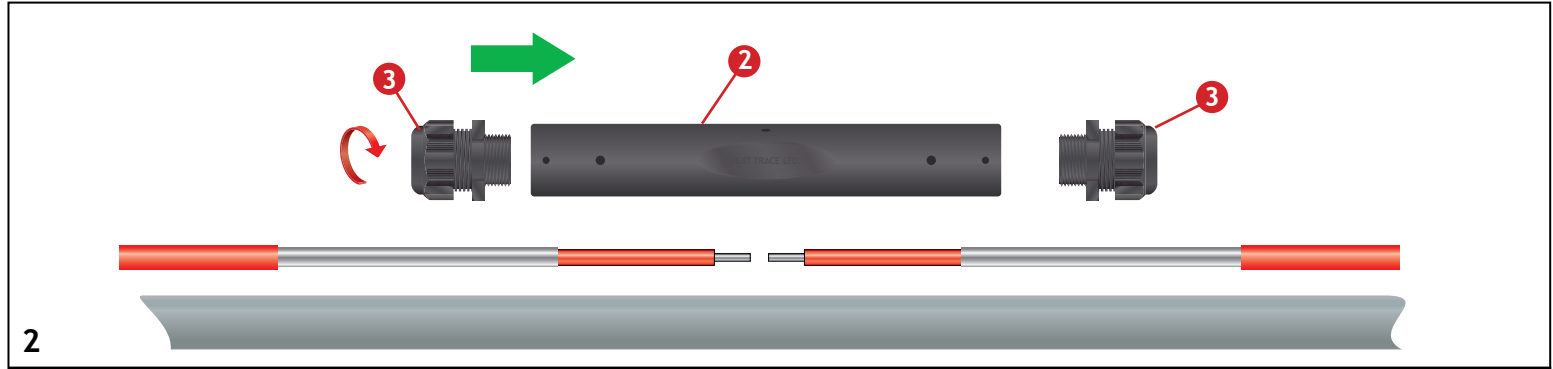

# Assembly of Termination

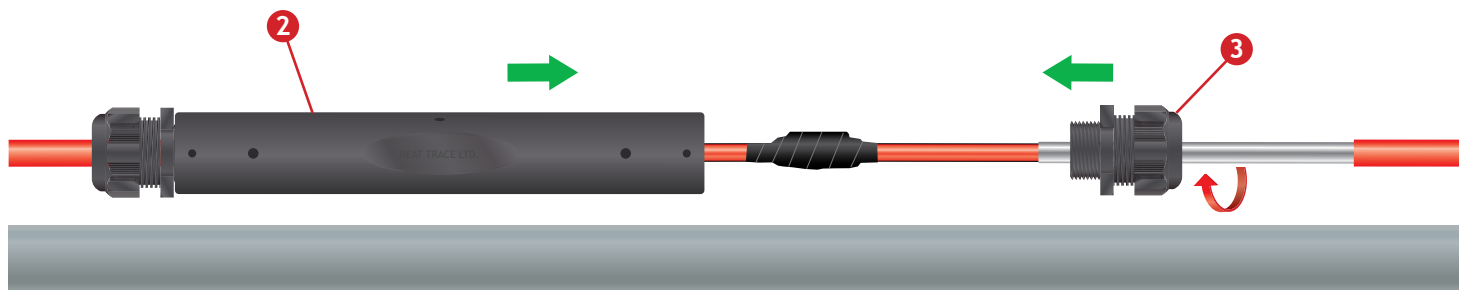

8

Use tools: 4

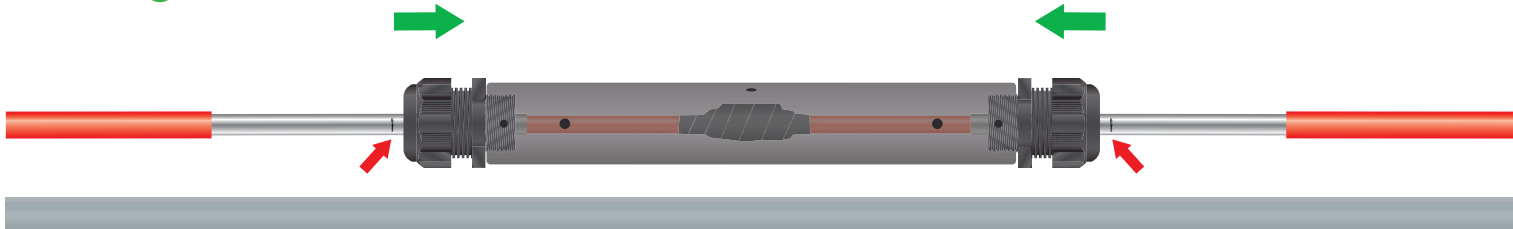

9

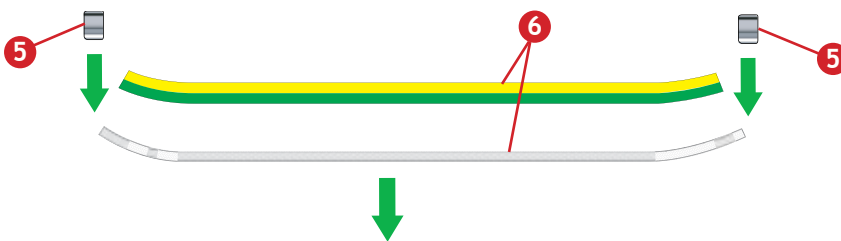

10

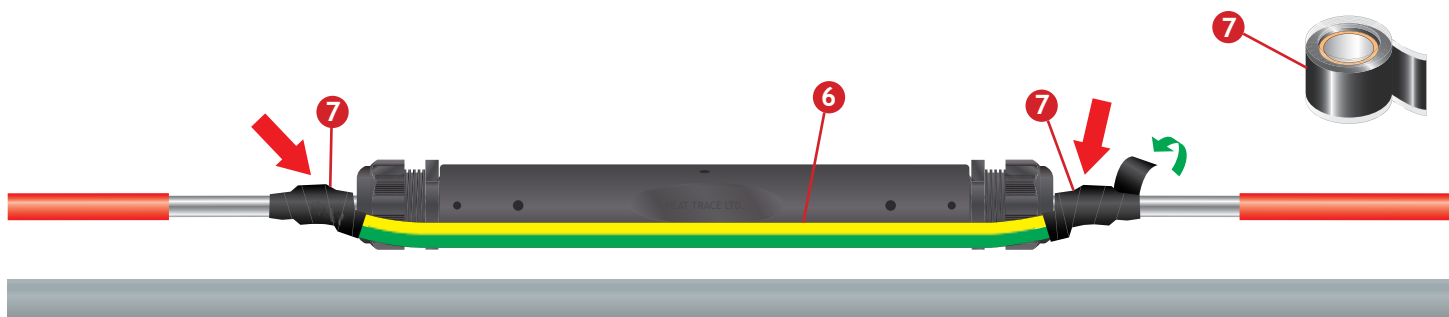

11

Use tools: 3 7

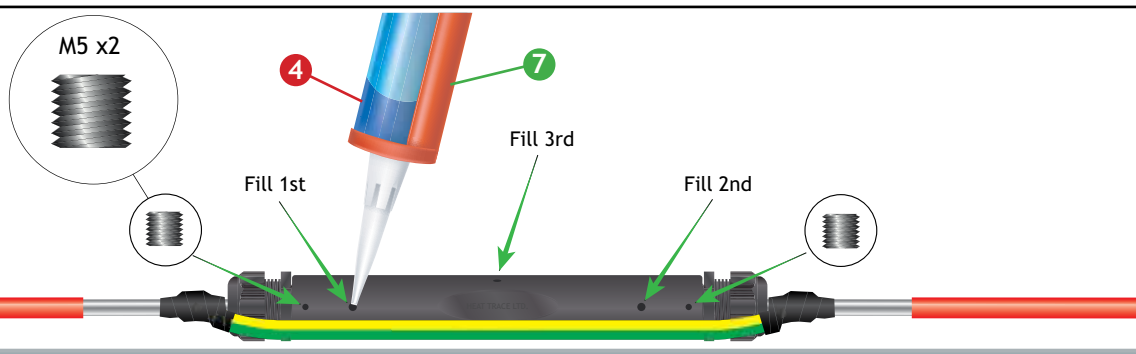

12

Use tools: 3

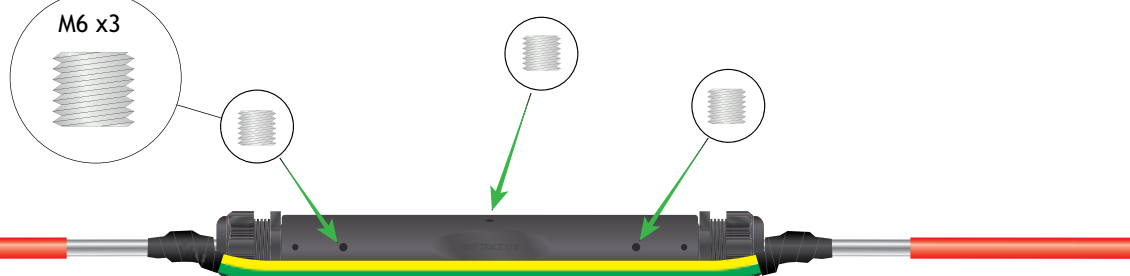

13