

ATEX: CML 19ATEX3390U
IECEX: CML 19.0133U

BPS5

FSEw-C
FSEw-CT
FSEw-CF
FSUw-N
FSUw-NF
SM-B



Made in the UK

PGS#			BPS#						BES5			RTV0.5

SPECIAL CONDITIONS FOR SAFE USE:
These termination kits and the cable that enters them shall be fixed to a secure mounting point.

The component shall only be used with constant power or self-regulating trace heating cables within the following ranges:
-40°C to 180°C (Standard RTV), -40°C to 250°C (High temperature RTV).

This is particularly relevant when the trace heating cable is installed on pipework that has a temperature outside these ranges, in this situation, the termination devices shall be positioned outside the insulation, and the user/installer shall ensure that they are not exposed to UV radiation.

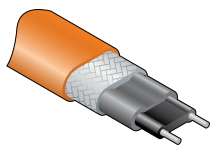
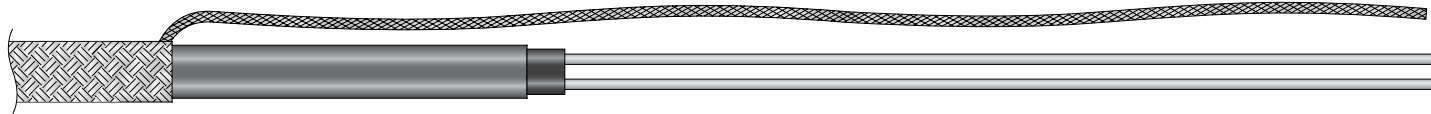
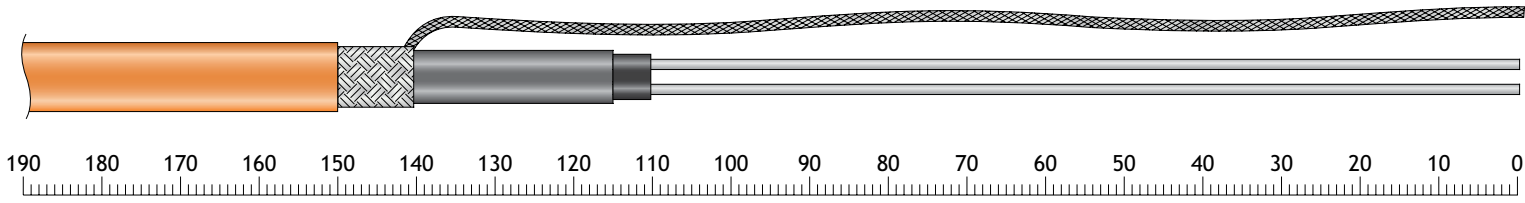

FSEw..C/CT/CF

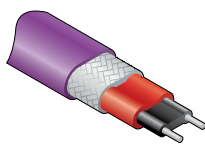

FSUw..N/NF

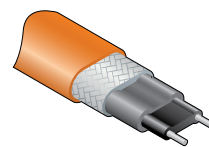

SM-B

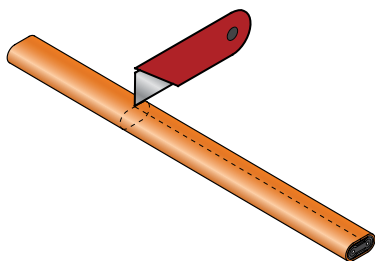

1

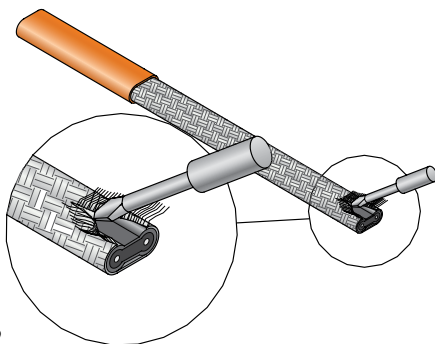

2

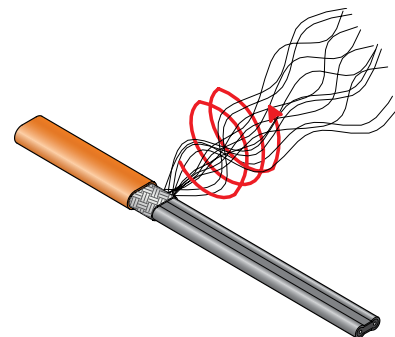

3

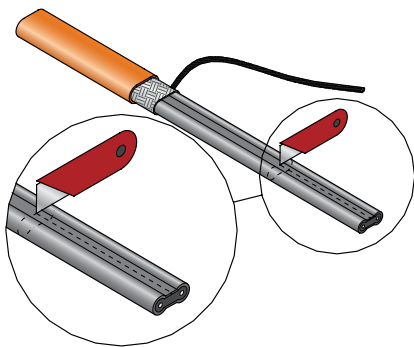

4

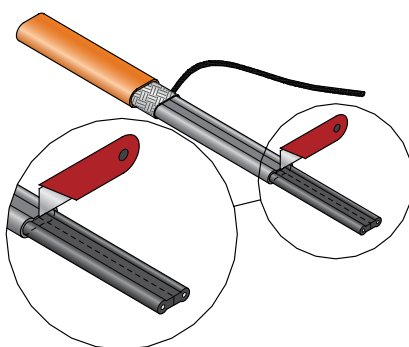

5

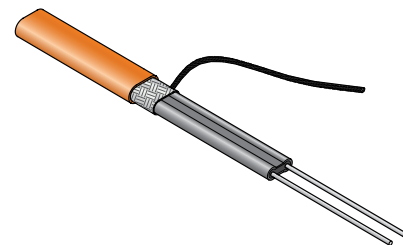

6

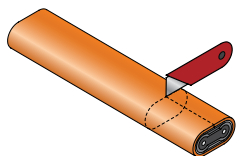
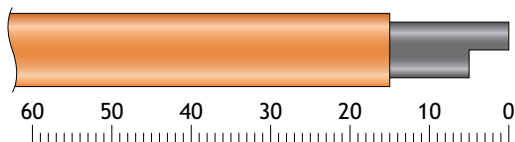

1

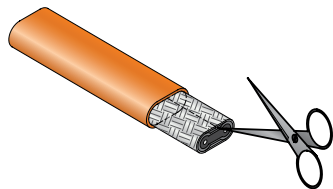

2

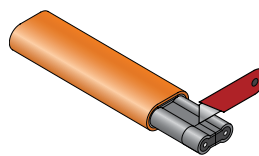

3

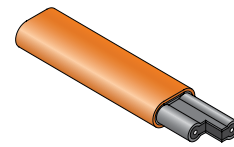

4